

# Инструкция по сборке Instructions for assembling furniture Instrukcja montażu mebli

Набор мебели для общей комнаты  
Collection Kolekcja mebli

## «BJORK»

Шкаф открытый 1D1S

Curboard 1D1S

Regał otwarty 1D1S

AH-055.19.00.00

Элемент для докупки

Dodatkowe elementy do zakupu

Additional element for buy

\*Фасад 120 P

\*Front 120 P

\*Front 120 P

AH-055.17.00.00

\*\*Фасад 120 S

\*\*Front 120 S

\*\*Front 120 S

AH-055.18.00.00

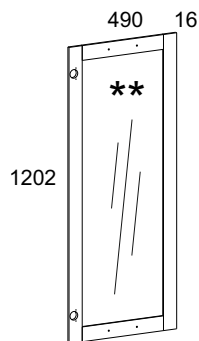
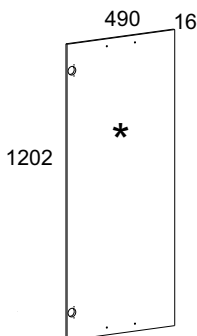
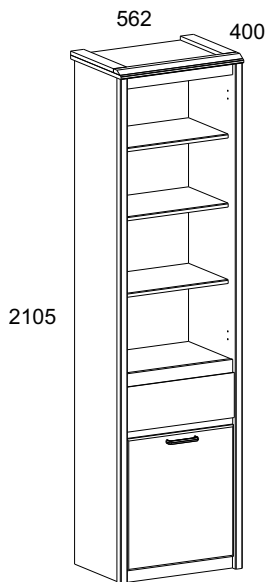

Дата изготовления

Production date

Data produkcji

Штамп ОТК

Stamp of Quality Department

Pieczęć Działu Jakości

**ИООО « АНРЭКС »**

Республика Беларусь, 224004

г.Брест, ул. Катин Бор, 119

тел/факс (+375162) 29-74-68



ЕАЭС №BY/112 11.01. TP025 018 04058

от 25.07.2018

по 23.07.2023

### Инструкция по эксплуатации.

Качество и комплектность изделия рекомендуется проверять в магазине при покупке в распакованном виде. Сборка изделия должна производиться в порядке, изложенном в настоящей инструкции. В процессе эксплуатации изделий необходимо периодически затягивать ослабленные винтовые соединения. В случае необходимости перемещения изделия по квартире перед его перестановкой, необходимо полностью освободить его от груза (матраца). Во избежание поломки имеющихся опор передвигать производить приподнимая изделие над уровнем пола. Запрещён прямой контакт с водой. Удаление пыли с изделий следует производить слегка влажной мягкой салфеткой. Во избежание коробления деталей и изменения цвета изделия следует избегать установки мебели на прямых солнечных лучах.

При эксплуатации изделий набора **ЗАПРЕЩАЕТСЯ**:

- устанавливать мебель вблизи отопительных приборов и вплотную к сырým стенам и в помещениях с относительной влажностью более 70%;
- температура нагрева элементов мебели не должна превышать +40 °С.
- в процессе сборки и эксплуатации изделий набора становиться ногами на горизонтальные щиты и витрины;
- применять химические чистящие средства для уборки мебели;

### Гарантии изготовителя

1. Гарантийный срок эксплуатации изделия - 24 месяца со дня продажи магазином. В период гарантийного срока изготовитель гарантирует ремонт изделий или их замену, если потребителем не нарушены правила эксплуатации.
2. Претензии предъявляются потребителем непосредственно в торгующую организацию, в которой была приобретена мебель, предъявив настоящую "Инструкцию по сборке" и копию товарного чека.
3. Изделие **Шкаф открытый 1D1S (Фасад 120 P, Фасад 120 S)**, входящее в состав набора мебели для общей комнаты **«BJORK»**, соответствует требованиям ГОСТ 16371-2014, ТР ТС 025/2012.
4. Срок службы мебели - 5 лет.
5. Предприятие-изготовитель оставляет за собой право вносить изменения в конструкцию изделия, не ухудшая его конструктивные и эксплуатационные характеристики.
6. Для сборки изделий рекомендуется привлекать квалифицированных специалистов.

### Запах

От новой мебели может исходить запах материалов, из которых она изготовлена.

Запах может сохраняться в течение трех недель с момента сборки. Для снижения интенсивности запаха рекомендуется:

- для мягкой мебели - пропылесосить изделие и проветрить помещение. Повторять 3-4 раза в день.
- для корпусной мебели - протирать ткань, смоченной мягким моющим средством, вытирать чистой сухой тканью и проветривать помещение, предварительно открывая все двери и ящики изделия. Повторять 3-4 раза в день.

**Важно!** Сохраните, пожалуйста, инструкцию в случае повторной сборки мебели или рекламации. В случае составления рекламации пользуйтесь, пожалуйста, обозначением из

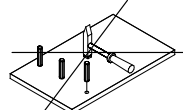
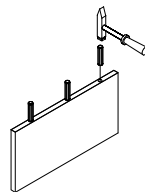

**PL**

### Przy eksploatacji mebli zabrania się:

- ustawiać meble w pobliżu grzewczych przyrządów i obok wilgotnych ścian, a także w pomieszczeniach ze względną wilgotnością więcej niż 70%;
- temperatura nagrzewania elementów mebli nie może przekraczać +40°C;
- w trakcie montażu i eksploatacji mebli stawać nogami na poziome panele i witryny;
- stosować chemiczne środki czyszczące do sprzątania mebli;
- nie należy narażać na kontakt z wodą.

### Gwarancja producenta

1. Gwarancyjny termin eksploatacji wyrobu - 24 miesiące z dnia sprzedaży. W okresie gwarancyjnego terminu producent gwarantuje naprawę wyrobów lub ich zamianę, jeżeli reguły eksploatacji nie zostały naruszone przez nabywcę.
2. Roszczenia są przekazywane przez nabywcę bezpośrednio do handlującej organizacji, w której były nabyte meble, tylko przy okazaniu danej "Instrukcji montażu" wraz z dokumentem zakupu.
3. Wyróby **Regał otwarty 1D1S (Front 120 P, Front 120 S)**, wchodzący w zestaw mebli **"BJORK"**, odpowiada wymaganiam Norm Państwowych 16371-2014, TP TC 025/2012
4. Trwałość użytkowa mebli - 5 lat.
5. Firma-producenta pozostawia za sobą prawo do wprowadzania zmian w konstrukcje wyrobów, nie pogarszając ich konstruktywne i eksploatacyjne charakterystyki.
6. Do montażu wyrobów zaleca się skorzystanie z pomocy wykwalifikowanych specjalistów.

**Ważne!** Proszę zachować instrukcję w razie ponownego montażu mebli lub reklamacji. Podczas składania reklamacji prosimy o korzystanie z oznaczeń z instrukcji.

**EN**

### Instruction manual.

It's advised to check the quality and completeness of the product in the store when buying unpacked. Assembling of the product should be done the way it's described in this manual. While the product is in service loose screw connections should be periodically tightened. If it's necessary to move items around the apartment before moving you should release the product completely from the load (the mattress). To prevent damage to existing supports the product should be lifted before moving. Furniture should not be exposed to contact with water. Dusting the product should be done with a slightly damp soft cloth. To prevent warping of parts and discoloration of products do not install furniture in direct sunlight.

### While the product is in service it's PROHIBITED TO:

- Install furniture near heating devices, close to the raw walls and in rooms with a relative humidity of more than 70%;
- heat elements of furniture to the temperature higher +40°C;
- step on the horizontal shields and windows during assembly and use of the products set;
- use chemical cleaners for cleaning furniture;

### Manufacturer's warranty.

1. The warranty period of use of the product - 24 months from the date of sale. During the warranty period the manufacturer guarantees repair or replacement of products, if the user has not violated operating rules.
2. Claims should be made by the consumer directly to the trading organization, in which furniture was purchased, presenting the "Instruction manual" and a copy of the sales receipt.
3. The products, **Cupboard 1D1S (Front 120 P, Front 120 S)**, which is a part of a set **"BJORK"**, meets the requirements of GOST 16371-2014, TR TS 025/2012.
4. The lifetime of furniture - 5 years.
5. The manufacturer reserves the right to make changes in product design, without compromising its design and application requirements.
6. To assemble the products it's recommended to attract qualified personnel.

**It is important!** Keep the instruction in case of reassembly of furniture or complaint. When making a claim use the notation from the instruction.

| № п/п | Длина<br>мм. | Ши-<br>рина<br>мм. | Тол-<br>щина<br>мм. | Кол-<br>во<br>шт. | № пачки |
|-------|--------------|--------------------|---------------------|-------------------|---------|
| 1     | 562          | 400                | 32                  | 1                 | 1/3     |
| 30    | 494          | 335                | 16                  | 1                 | 1/3     |
| 54    | 494          | 351                | 16                  | 1                 | 1/3     |
| 71    | 494          | 315                | 16                  | 4                 | 1/3     |
| 91    | 2064         | 394                | 32                  | 1                 | 2/3     |
| 92    | 2064         | 394                | 32                  | 1                 | 2/3     |
| 158   | 490          | 184                | 16                  | 1                 | 3/3     |
| 176   | 320          | 100                | 16                  | 1                 | 3/3     |
| 177   | 320          | 100                | 16                  | 1                 | 3/3     |
| 186   | 436          | 100                | 16                  | 1                 | 3/3     |
| 219   | 490          | 538                | 16                  | 1                 | 3/3     |
| 259   | 494          | 70                 | 16                  | 2                 | 1/3     |
| 260   | 494          | 50                 | 16                  | 2                 | 1/3     |
| 311   | 466          | 325                | 2,5                 | 1                 | 3/3     |
| 340   | 1227         | 506                | 2,5                 | 1                 | 3/3     |
| 341   | 792          | 506                | 2,5                 | 1                 | 3/3     |

**Элемент для докупки**  
**Dodatkowe elementy do zakupu**  
**Additional element for buy**

\*Фасад 120 P

\*Front 120 P

\*Front 120 P

\*\*Фасад 120 S

\*\*Front 120 S

\*\*Front 120 S



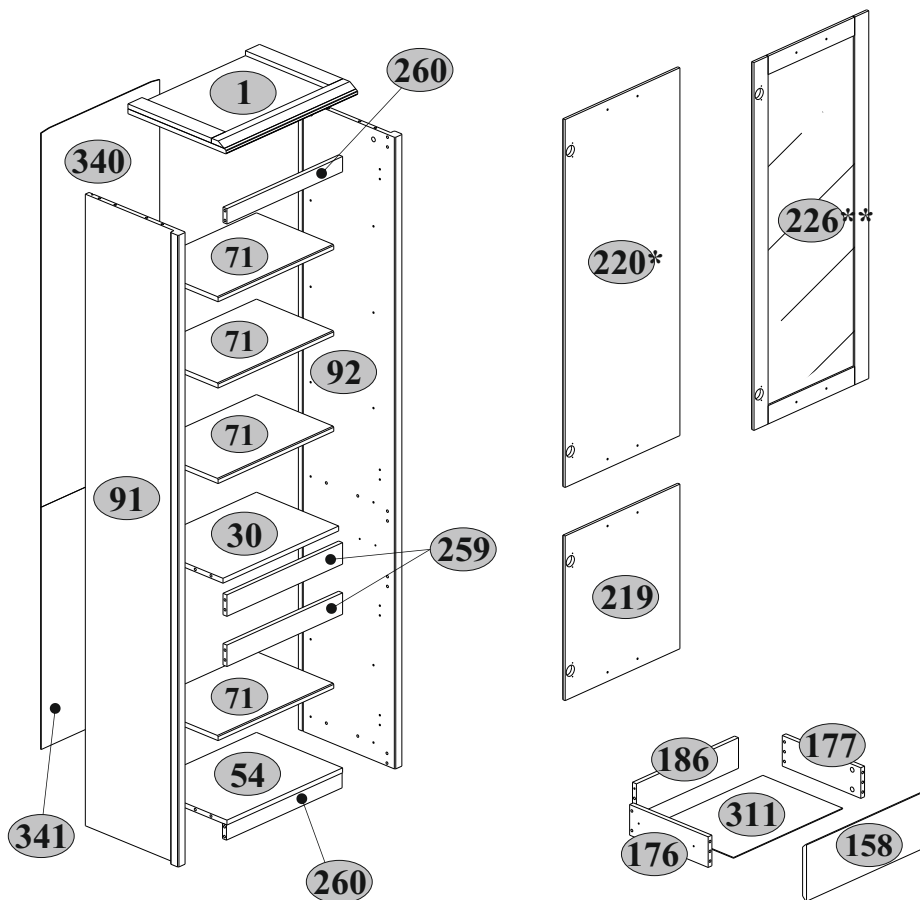



| № п/п | Длина<br>мм. | Ши-<br>рина<br>мм. | Тол-<br>щина<br>мм. | Кол-<br>во<br>шт. | № пачки |
|-------|--------------|--------------------|---------------------|-------------------|---------|
| *220  | 490          | 1202               | 16                  | 1                 | 1/1     |
| *226  | 490          | 1202               | 16                  | 1                 | 1/1     |



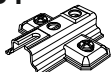











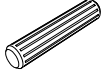
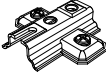



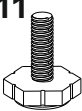

Элемент для докупки  
 Dodtkowe elementy do zakupu  
 Additional element for buy

\*Фасад 120 P  
 \*Front 120 P  
 \*Front 120 P

\*\*Фасад 120 S  
 \*\*Front 120 S  
 \*\*Front 120 S

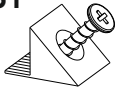
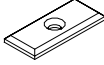
|  |  |   |  |
|--|--|---|--|
| <b>D1</b><br><br>4*,4** | <b>E6</b><br><br>4*,4**         | <b>H36</b><br><br>2*,2**           | <b>M4</b><br><br>M4x22 4*,4** |
| <b>Q</b><br><br>6*,6**  | <b>R23</b><br><br>6,3x13 8*,8** | <b>R102</b><br><br>3,5x16 10*,10** |  |

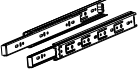

|  |  |  |   |
|--|--|--|---|
| <b>A1</b><br><br>7x34 16    | <b>A2</b><br><br>16         | <b>B5</b><br><br>10x50 1    | <b>C1</b><br><br>8x35 32 |
| <b>D1</b><br><br>2          | <b>E6</b><br><br>2          | <b>H36</b><br><br>1         | <b>I</b><br><br>S4 1     |
| <b>M4</b><br><br>M4x22 2    | <b>N11</b><br><br>4         | <b>N19</b><br><br>4         | <b>P5</b><br><br>16      |
| <b>Q</b><br><br>5           | <b>R3</b><br><br>3x20 14    | <b>R23</b><br><br>6,3x13 4  | <b>R24</b><br><br>7x50 4 |
| <b>R27</b><br><br>5,0x13 10 | <b>R102</b><br><br>3,5x16 6 | <b>S1</b><br><br>15         | <b>S3</b><br><br>3       |
| <b>S5</b><br><br>Ø18 8      | <b>S11</b><br><br>8         | <b>U</b><br><br>90x35x15 1 | <b>Z10</b><br><br>300 1  |

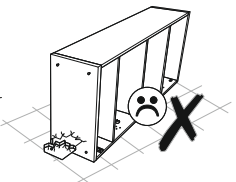
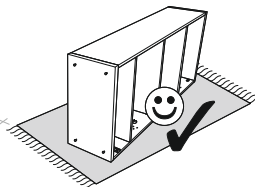
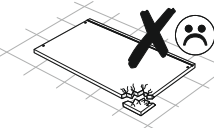
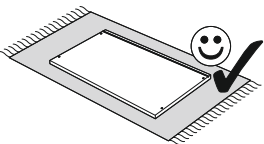
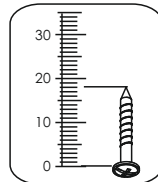
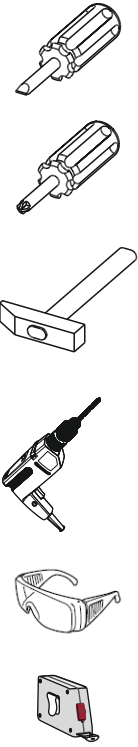
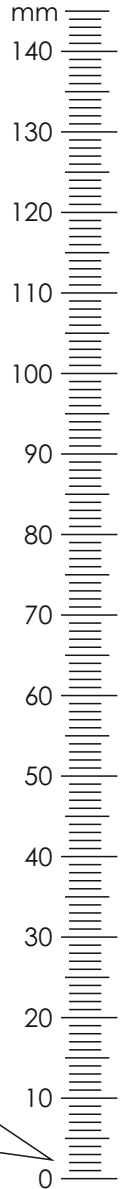

**1**

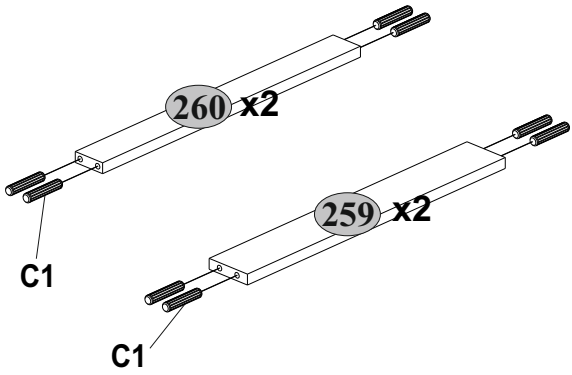
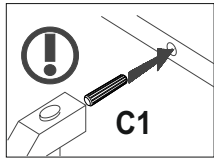
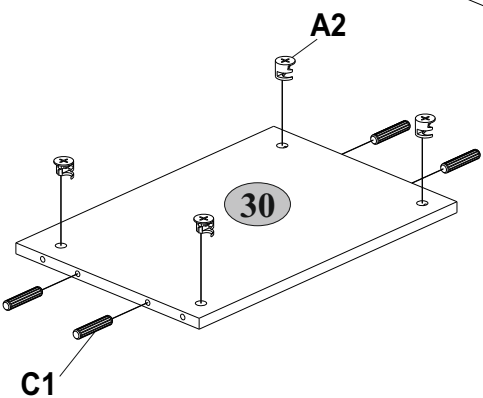
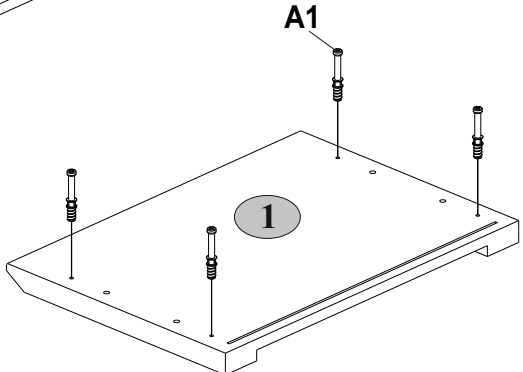
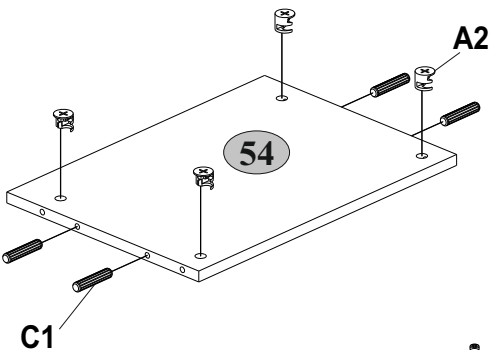
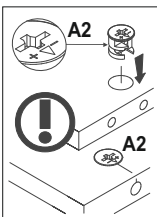
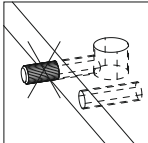
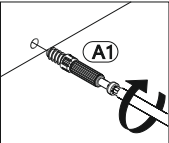
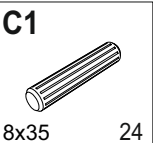
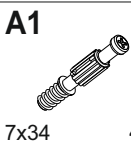

**2 A**

7x34



8



4 8x35



4 2(4\*,4\*\*)



4



4



16



6,3x13 4(8\*,8\*\*)



5,0x13

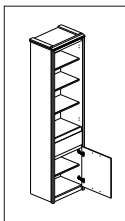

8

**Z10**

300

1

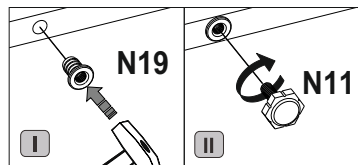
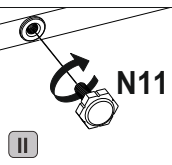
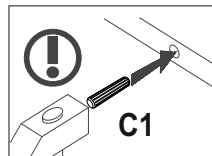
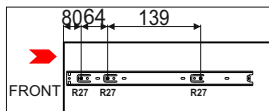
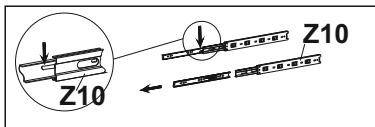
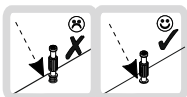
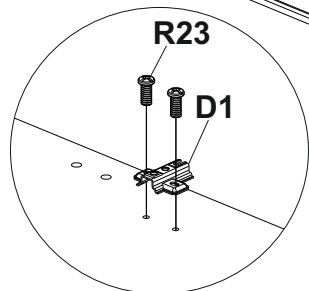
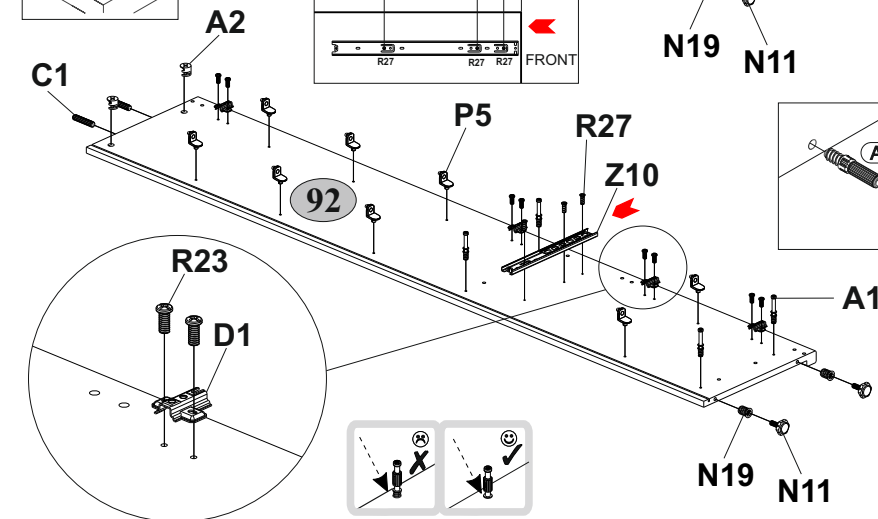
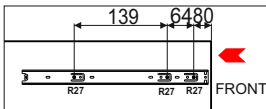
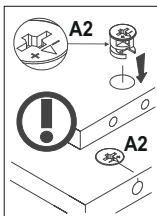
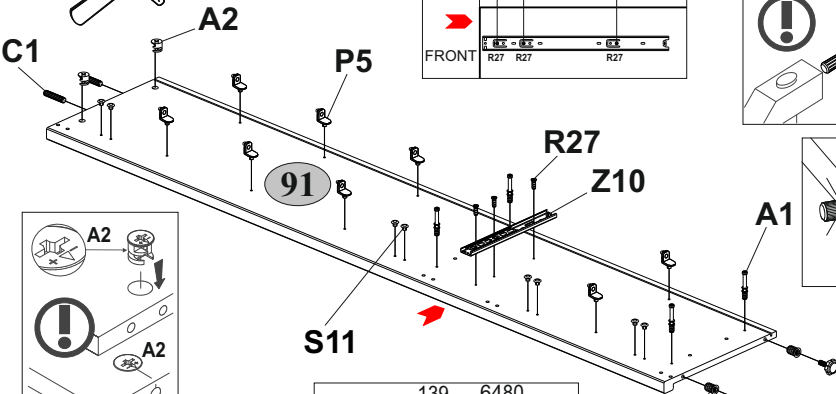
**I****II****C1**



# 2 B

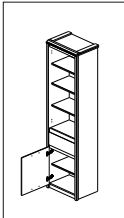

|                        |                 |                                   |                             |                 |
|------------------------|-----------------|-----------------------------------|-----------------------------|-----------------|
| <b>A1</b><br>7x34<br>8 | <b>A2</b><br>8  | <b>C1</b><br>8x35<br>4            | <b>D1</b><br>2(4*,4**)<br>4 | <b>N11</b><br>4 |
| <b>N19</b><br>4        | <b>P5</b><br>16 | <b>R23</b><br>6,3x13<br>4(8*,8**) | <b>R27</b><br>5,0x13<br>6   | <b>S11</b><br>8 |

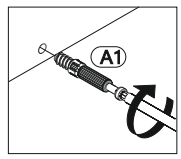
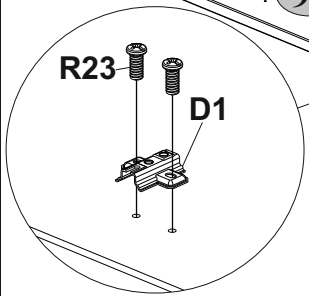
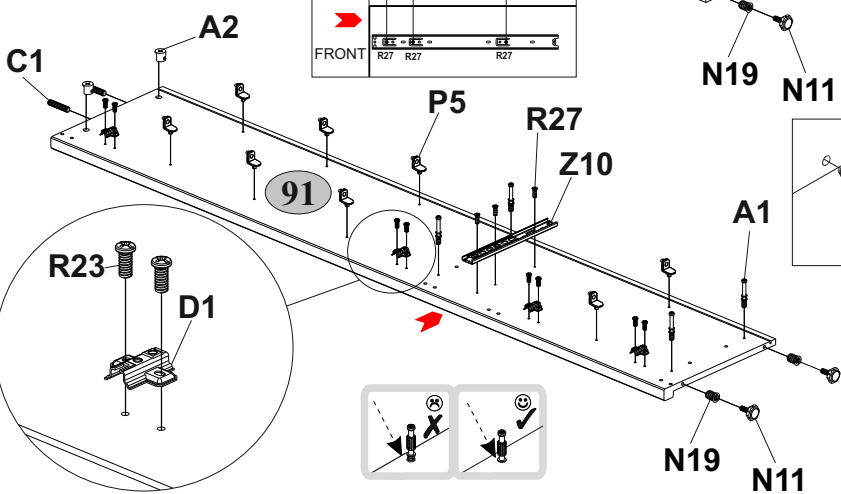
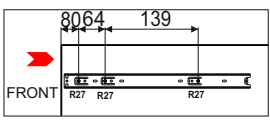
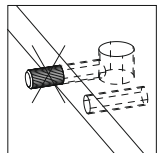
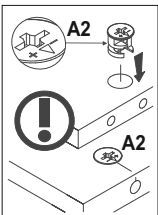
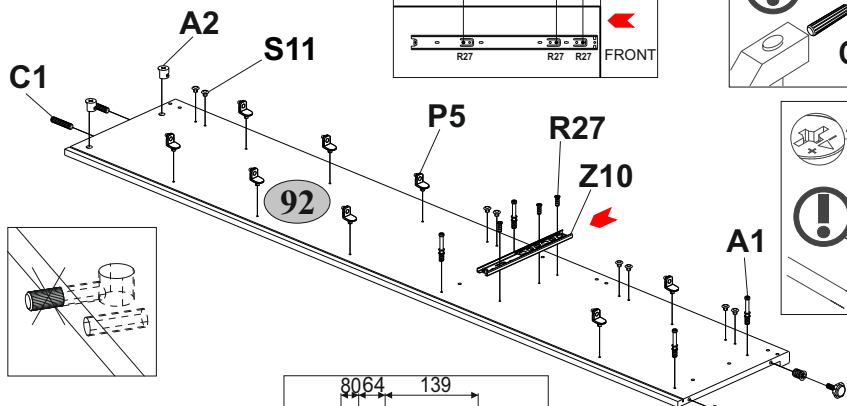
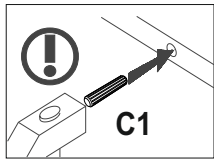
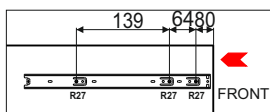
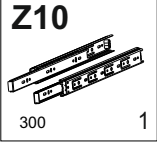
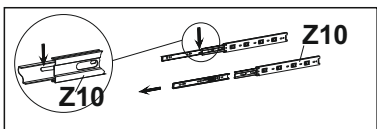
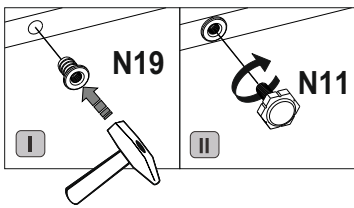

3

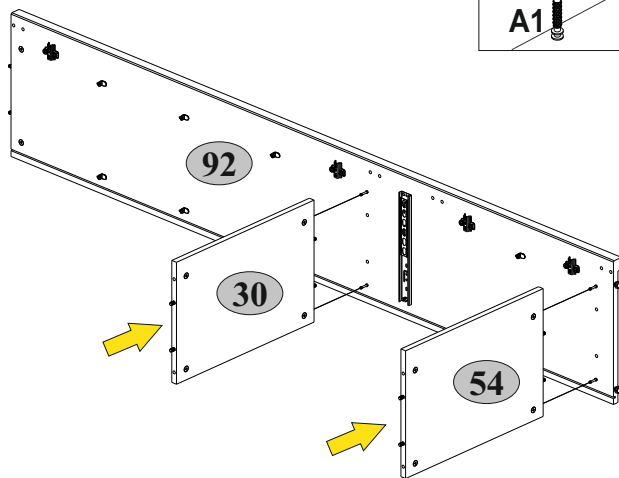

4

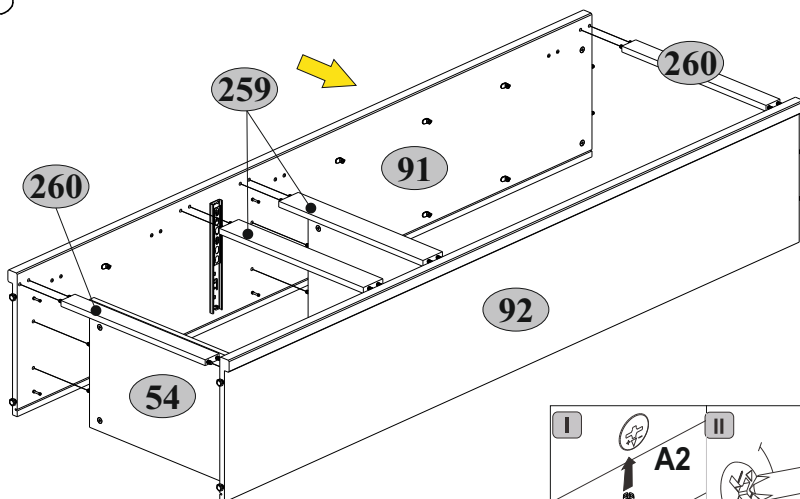

5

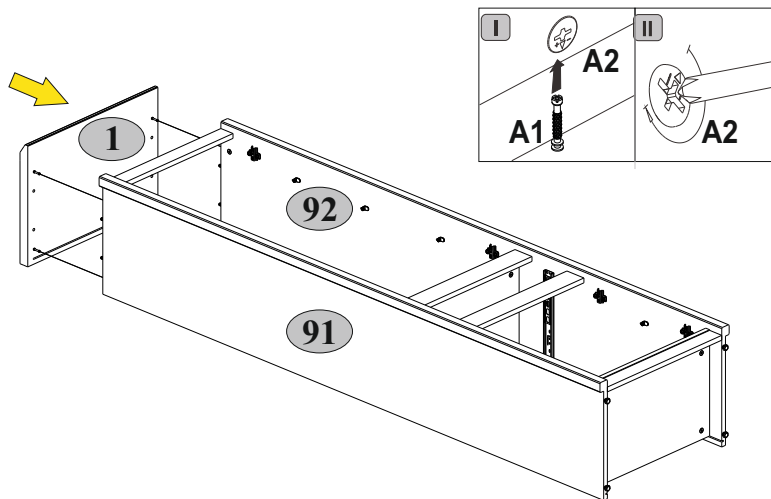

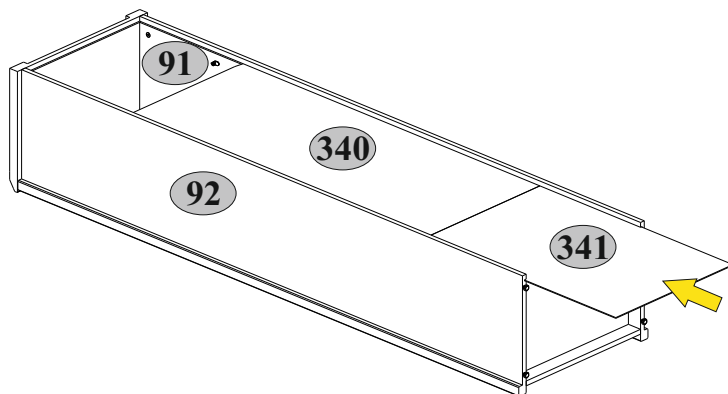

6

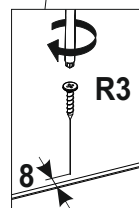
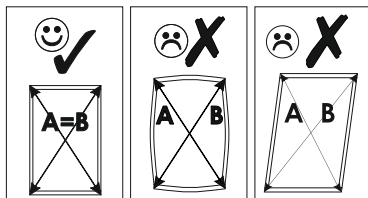
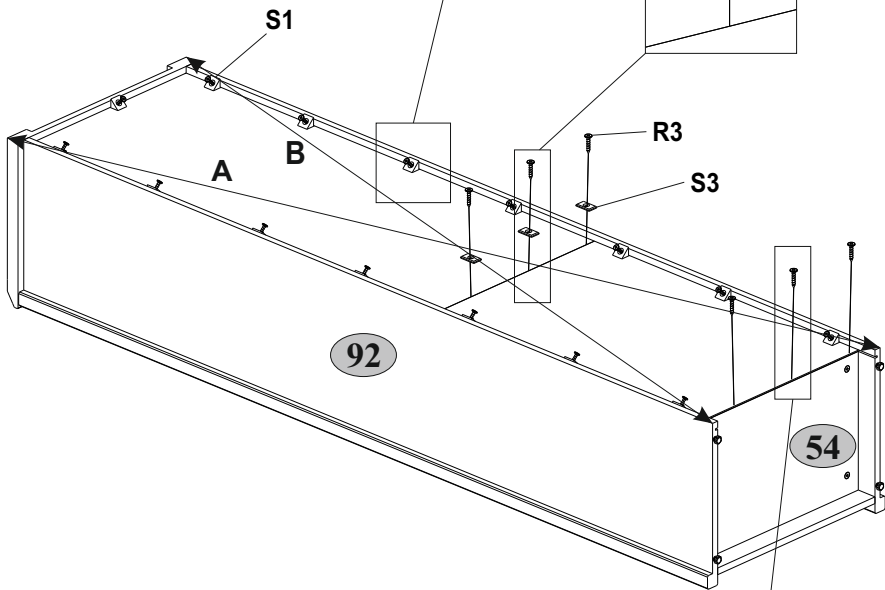
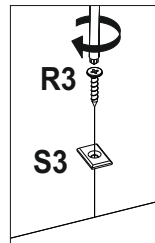
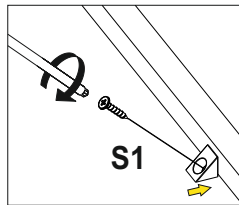
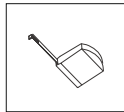
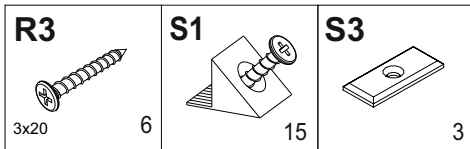

7

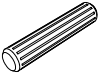

8

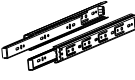
|  |  |   |   |
|--|--|---|---|
| <b>A2</b><br> | <b>C1</b><br> | <b>R27</b><br> | <b>Z10</b><br> |
| 4  | 8x35   | 4   | 5,0x13  |
| 4  | 300  | 1   |   |

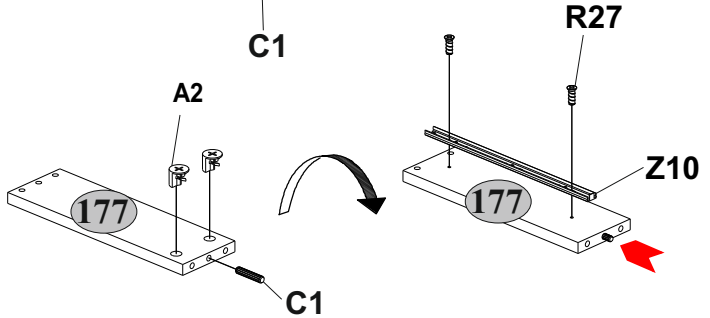
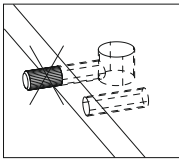
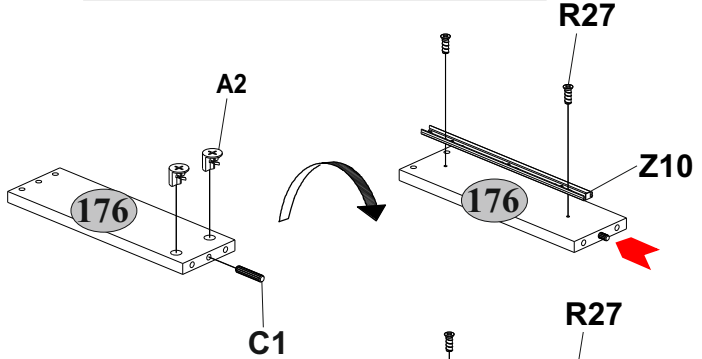
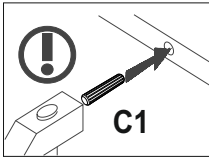
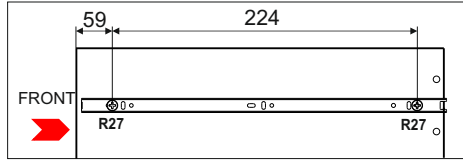
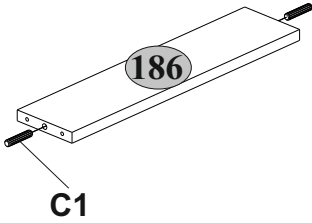
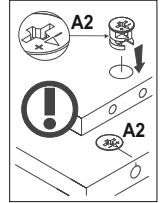

9

|  |
|--|
| <b>A1</b><br> |
| 7x34   |
| 4  |

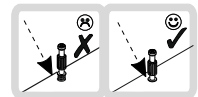
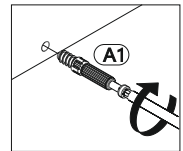
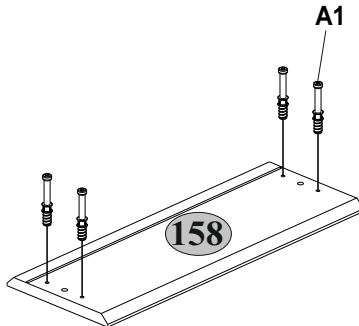

**10**

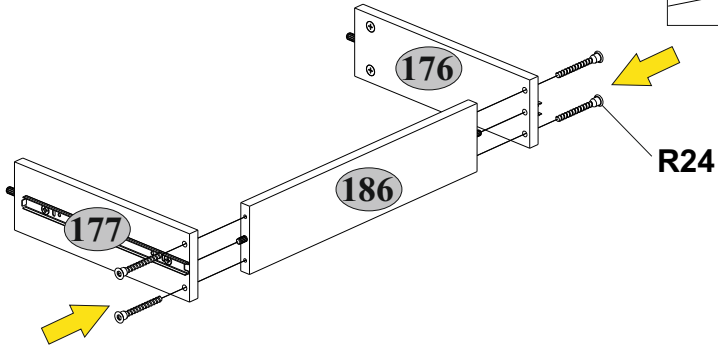
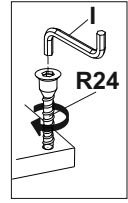
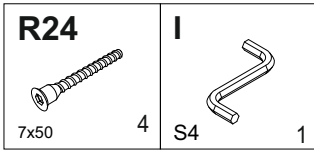

**11**

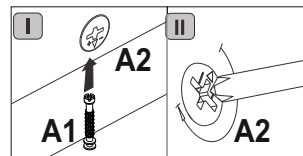
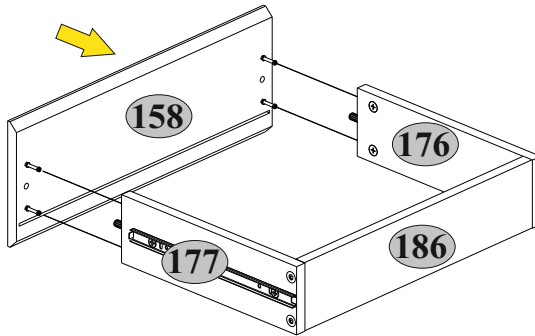

12

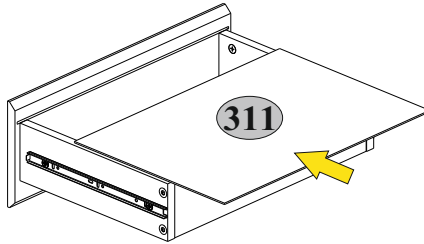



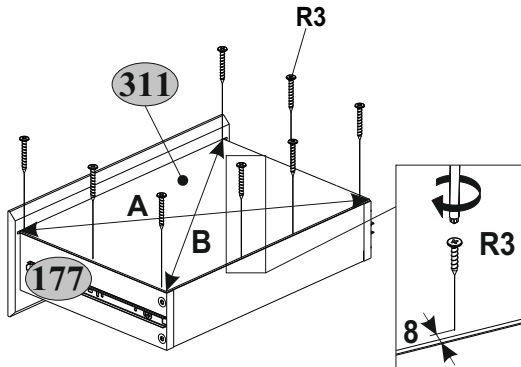
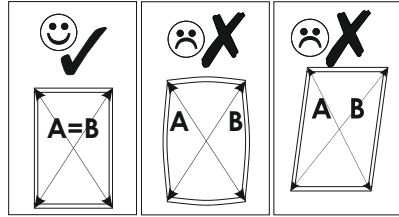
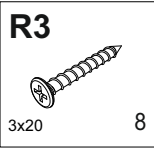

13

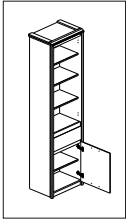

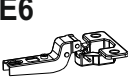
# 14A





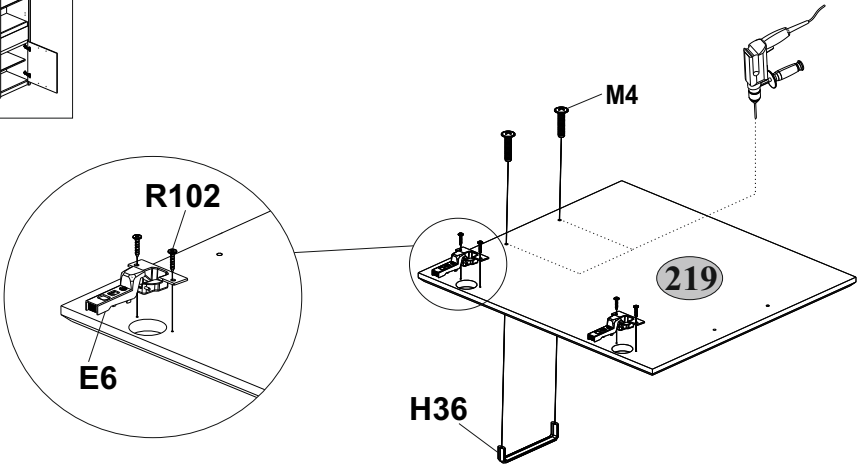

|   |  |  |   |
|---|--|--|---|
| <b>E6</b><br><br>2 | <b>H36</b><br><br>1 | <b>M4</b><br><br>M4x22<br>2 | <b>R102</b><br><br>3,5x16<br>4 |
|---|--|--|---|

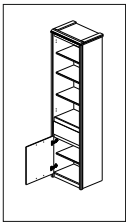

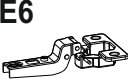
# 14B





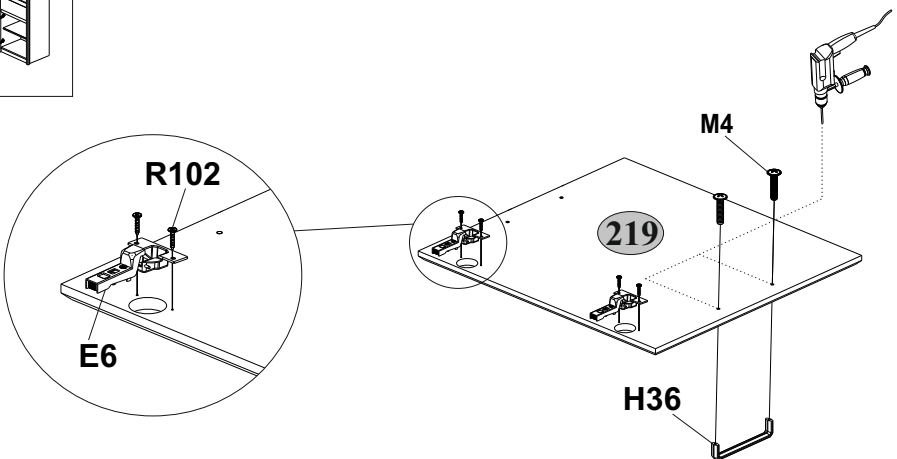

|   |  |  |   |
|---|--|--|---|
| <b>E6</b><br><br>2 | <b>H36</b><br><br>1 | <b>M4</b><br><br>M4x22<br>2 | <b>R102</b><br><br>3,5x16<br>4 |
|---|--|--|---|



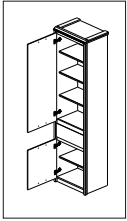

# 15A





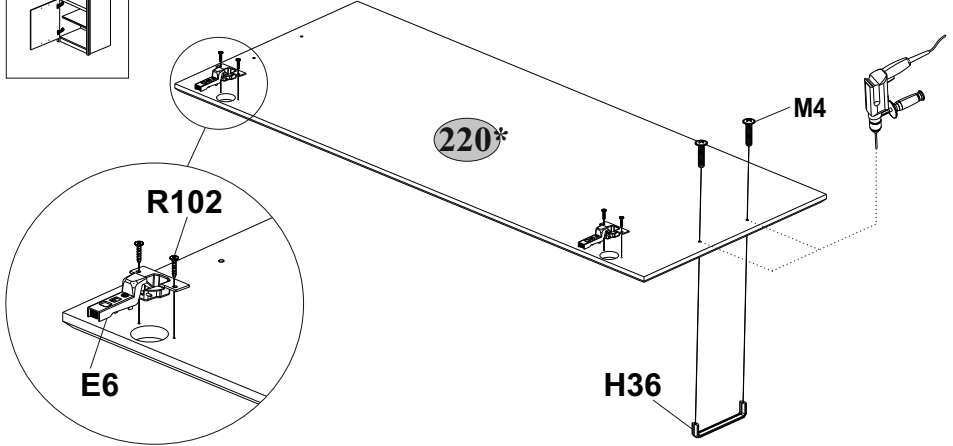

|  |   |  |   |
|--|---|--|---|
| <b>E6</b><br><br>2* | <b>H36</b><br><br>1* | <b>M4</b><br><br>M4x22 2* | <b>R102</b><br><br>3,5x16 4* |
|--|---|--|---|

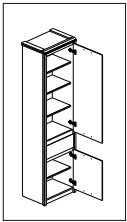

# 15B





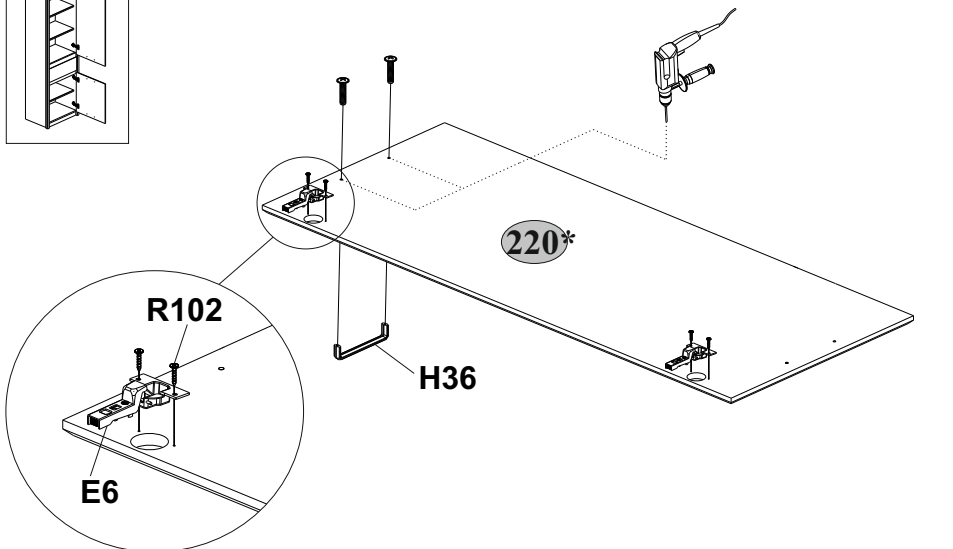

|  |   |  |   |
|--|---|--|---|
| <b>E6</b><br><br>2* | <b>H36</b><br><br>1* | <b>M4</b><br><br>M4x22 2* | <b>R102</b><br><br>3,5x16 4* |
|--|---|--|---|

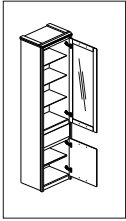

# 16A





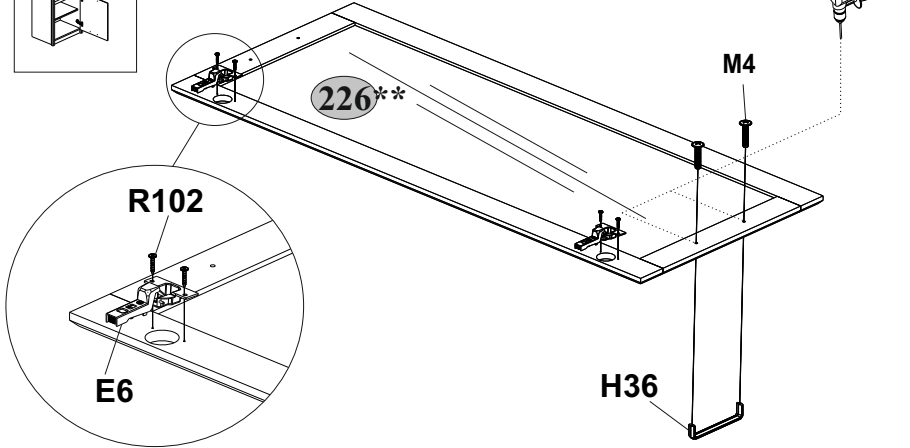

|   |  |   |  |
|---|--|---|--|
| <b>E6</b><br><br>2** | <b>H36</b><br><br>1** | <b>M4</b><br><br>M4x22 2** | <b>R102</b><br><br>3,5x16 4** |
|---|--|---|--|

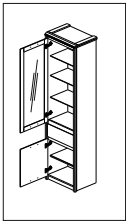

# 16B



|   |  |   |  |
|---|--|---|--|
| <b>E6</b><br><br>2** | <b>H36</b><br><br>1** | <b>M4</b><br><br>M4x22 2** | <b>R102</b><br><br>3,5x16 4** |
|---|--|---|--|

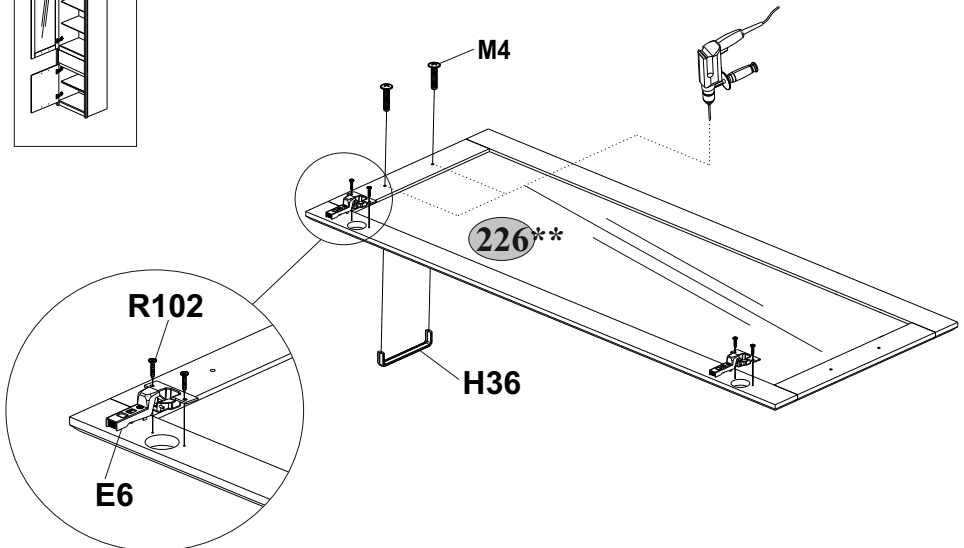

17

B5



10x50 1

Q



5(6\*,6\*\*) 1

S5



Ø18 8

R102



3,5x16 2

U



90x35x15 1

