

SK NÁVOD NA MONTÁŽ
 CZ MONTÁŽNÍ NÁVOD
 HU SZERELÉSI UTASÍTÁS
 DE MONTAGEANLEITUNG

MAURUS NEW MA 32

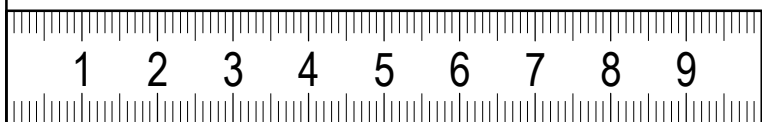

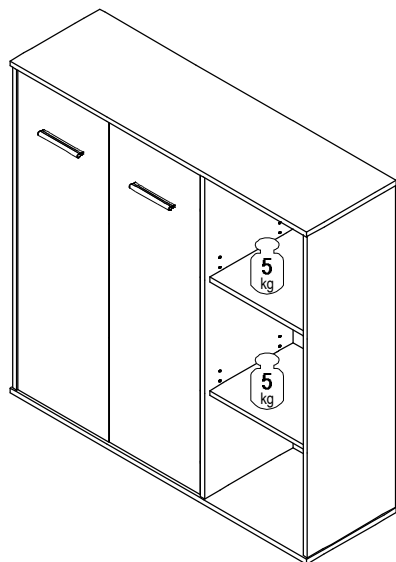

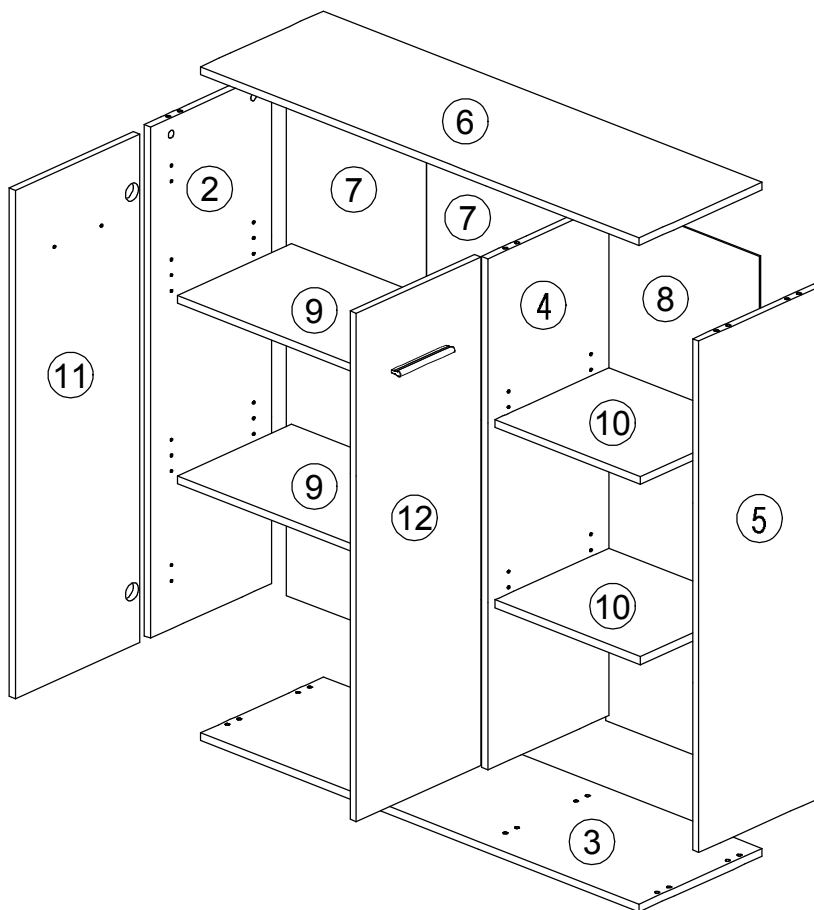

	1109
	1076
	335

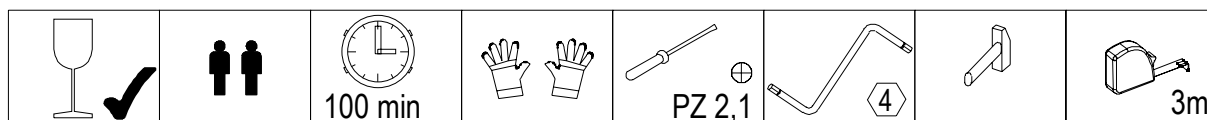
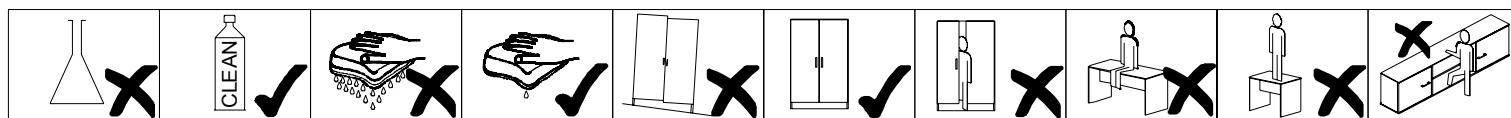
ID	ID	Image	Quantity	Weight
12447	2		1x	1/2
12432	3		1x	1/2
12448	4		1x	1/2
12449	5		1x	1/2
12431	6		1x	1/2
12450	7		2x	2/2
12451	8		1x	2/2
12433	9		2x	2/2
12434	10		2x	2/2
12452	11		1x	2/2
12453	12		1x	2/2

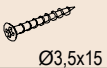
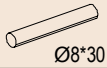

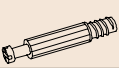
22430,00 Ø4x25	22244,01 Ø3,5*16	22243,00 Ø3,5x15	27000,00 Ø8*30		70013,01 	70021,01 	22300,00 Ø7x50	85101,01 	32030,00
A 4x	B 2x	C 8x	D 12x	E 6x	F 6x	G 6x	H 6x	J 16x	K 2x
22236,00 Ø2,5x16	24008,00 3,0	36001,01 	36001,01 	21102,00 Ø1,2x20	34800,00 	22213,00 Ø4x70	24103,00 Ø8	81103,00 	
L 10x	M 10x	N 4x	P 4x	Q 50x	S 6x	T 1x	U 1x	V 1x	

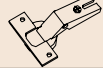



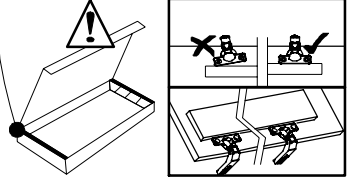
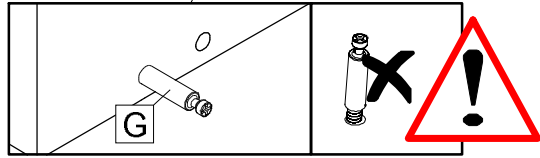
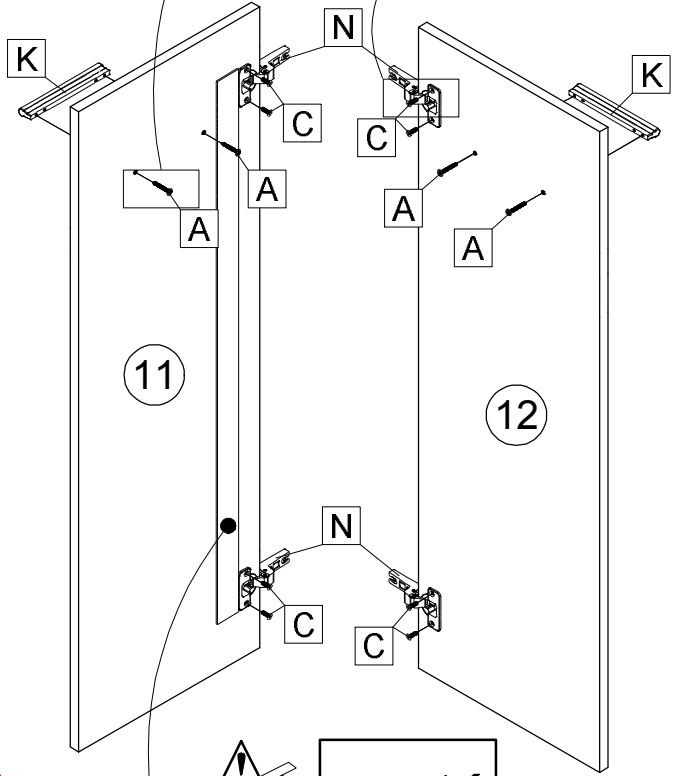
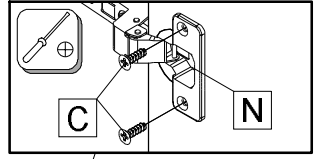
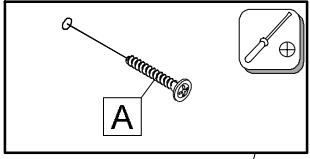
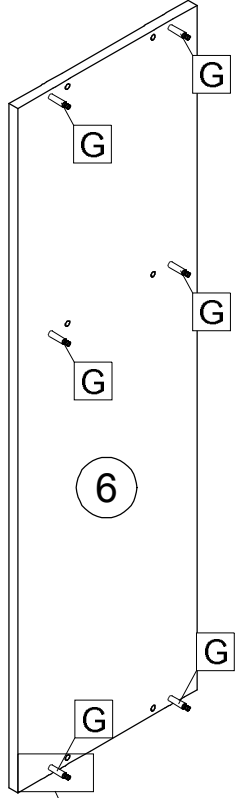
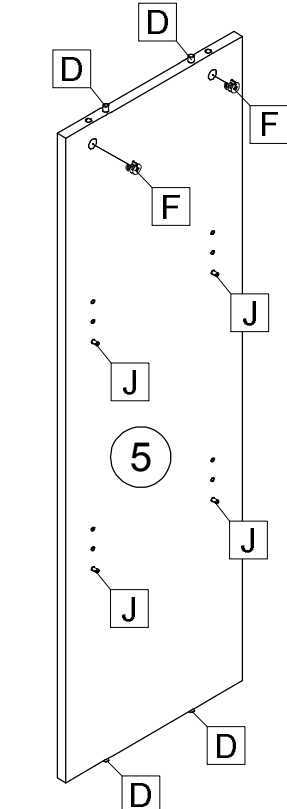
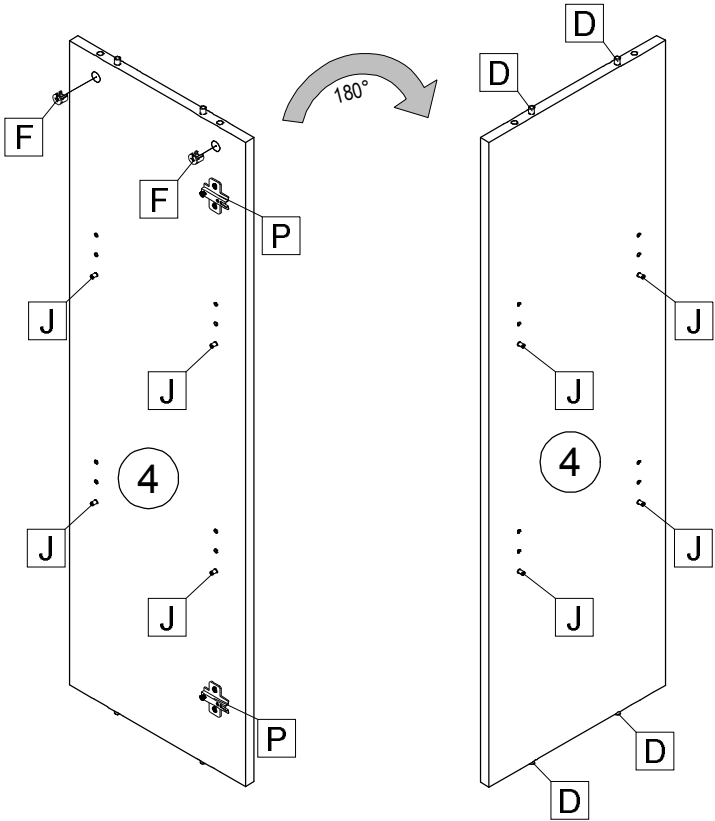
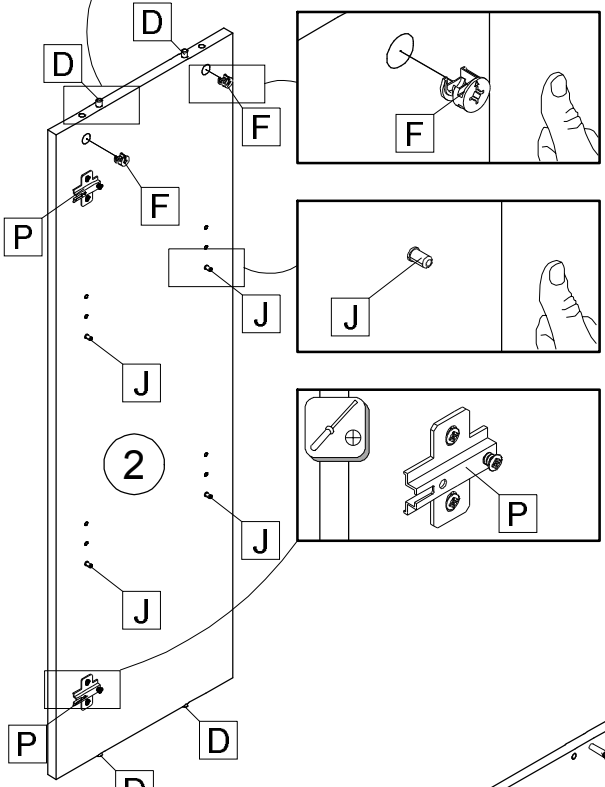
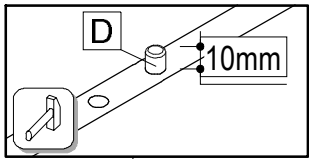

								
A 4x	C 8x	D 12x	F 6x	G 6x	J 16x	K 2x	N 4x	P 4x

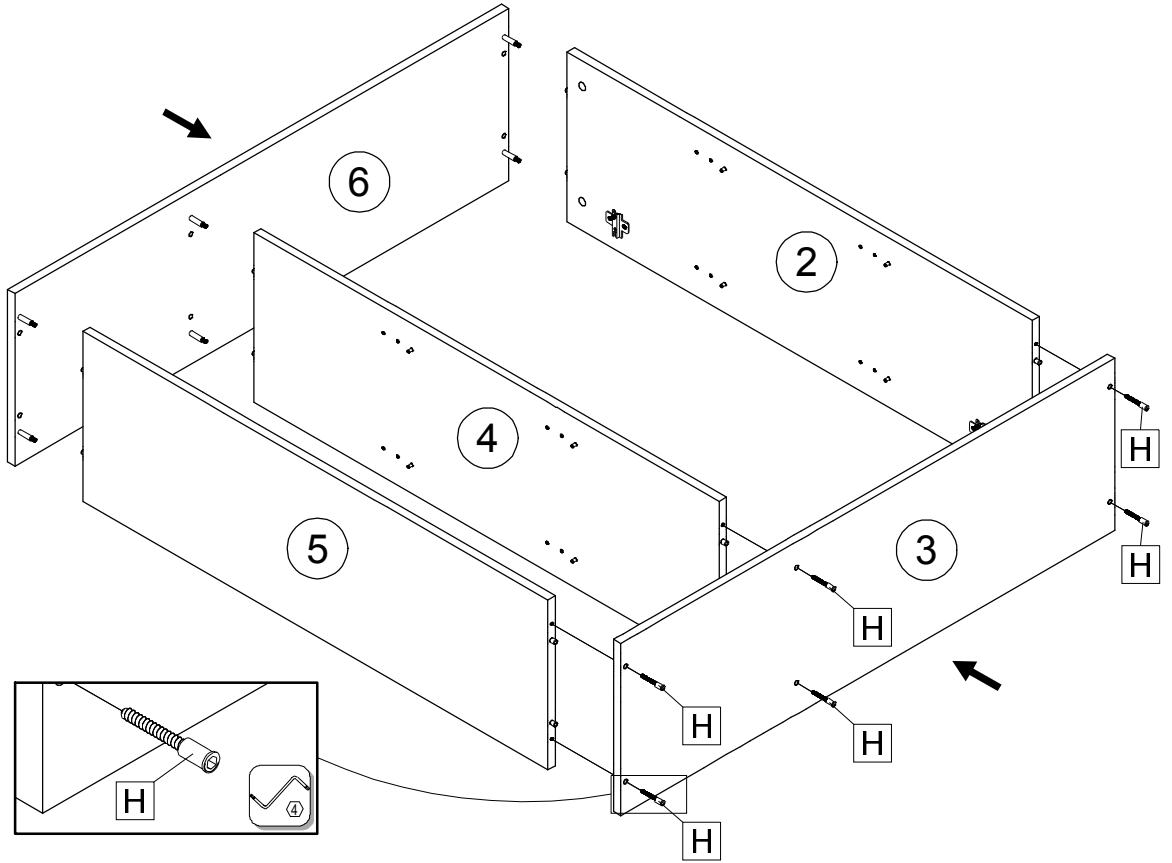
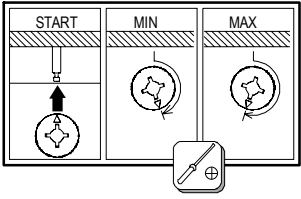

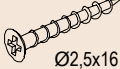
	Ø7x50
H	6x

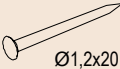

			
Ø2,5x16	3,0	Ø1,2x20	
L 10x	M 10x	Q 50x	S 6x

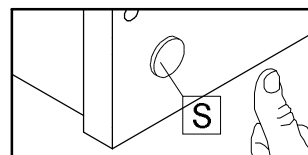
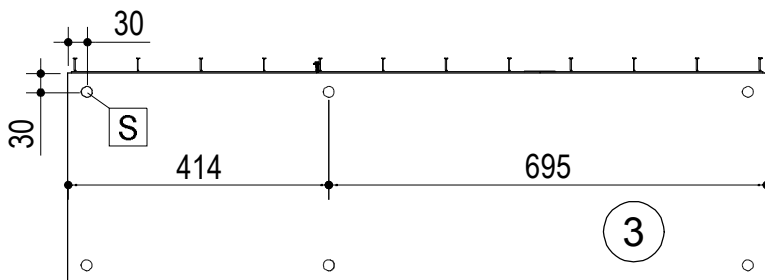
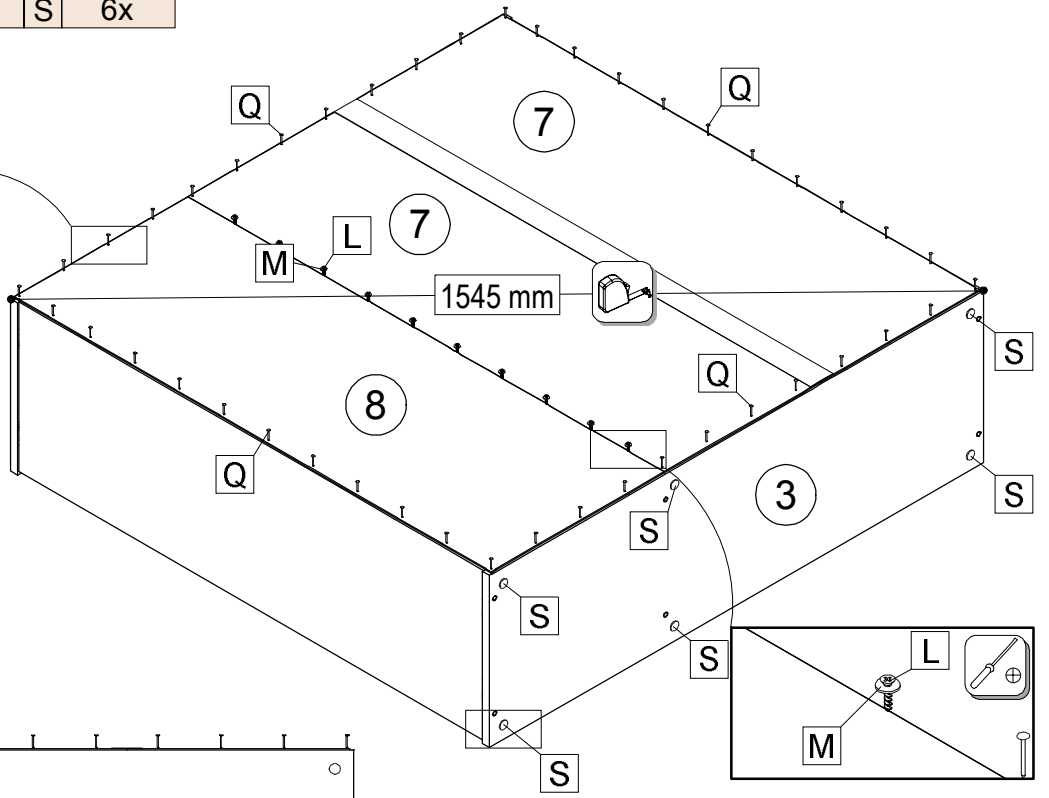
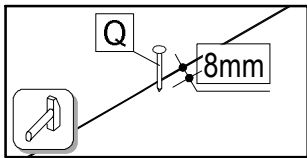

B 2x	T 1x
U 1x	V 1x
1. v = 1054	
2. Ø8	
3. U	
4. V B	
5. V T	

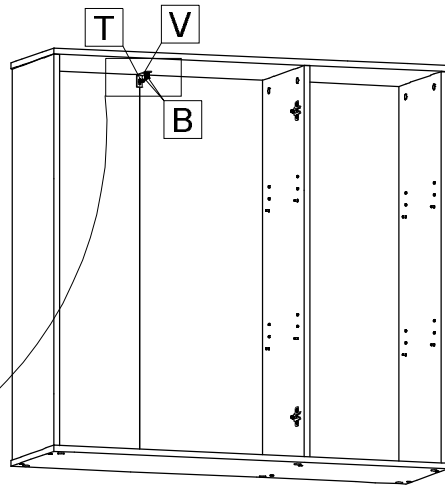
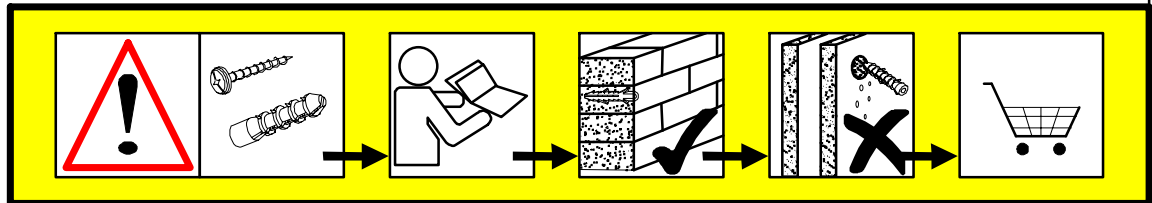

DE

Achtung! Die Wandbeschaffenheit ist vor der Montage unbedingt zu prüfen. Die beigelegten Universaldübel sind ausschließlich nur zur Verwendung für festes Mauerwerk wie Beton/Ziegel. Die Mauerdübel dürfen nicht bei Mauerwerk wie Hohlraumziegel, Leichtbausteinen, Gipskartonplatte oder anderer Rahmenbauweise verwendet werden. Bei diesen Mauerwerken sind gegebenenfalls Spezialdübel zu verwenden! Diese sind in einem Fachgeschäft (Baumarkt) erhältlich. Bei Nichteinhaltung wird seitens Produzenten/Händler und Importeur keine Haftung übernommen.

SK

Upozornenie! Pevnosť steny sa musí pred montážou bezpodmienečne skontrolovať. Univerzálne hmoždenky, ktoré sú obsiahnuté v balení, používajte jedine pre pevné murivo ako je betón/tehla. Hmoždenky sa nesmú používať v prípade ľahkého staveného muríva, dutina tehla, u sádkartónových dosiek alebo iných konštrukcií rámu. U týchto murív je nutné použiť špeciálne hmoždenky! Tieto je možné dostať v špeciálnych predajniach so stavebným materiálom (stavebniny). Pri nedodržaní pokynov nepreberajú výrobcovia/predajci a dodávateľa zodpovednosť za vzniknuté škody.

HU

Vigyázat! Szerelés előtt a falfelületet feltétlenül vizsgálja meg. A mellékelt univerzális tiplik kizárólag stabil falazathoz használható mint például beton/tegla. A fal tiplik nem használható könnyű építőkövek hez, üreg téglá, gipszkarton lapokhoz vagy más favázás építményekhez. Ezekhez a falfelületekhez csak speciális tiplik használhatóak, melyek szaküzletekben (barkácsruházakban) beszerezhetőek. Fentiek figyelmen kívül hagyása esetén a gyártó/kereskedő vagy forgalmazó nem vállal felelősséget.

CZ

Upozornění! Před montáží je nutné zkontrolovat stav stěny. Přiložené univerzální hmoždinky jsou určeny pouze k použití pro pevné zdivo jako beton/cihly. Hmoždinky do zdi se nesmí používat u dutinová cihla, zdiva jako pórovitý stavební kámen, sádkartónová deska nebo jiný měkký materiál. U těchto zdív jsou nutné použít speciální hmoždinky! Jsou k dostání v speciálních prodejnách se stavebním materiálem. Při nedodržení těchto pokynů výrobce/prodejece a dovozce neručí za způsobené škody.

E 6x

